

GEMÜ 850

Variable area flowmeter



Features

- Good level of accuracy, simple operation
- Clear and large size printed scale
- ATEX version available as an option
- Over 500 standard scales and 13,000 special scales are available with further scales on request
- Corrosion-resistant plastic parts

Description

The GEMÜ 850 flowmeter operates according to the variable area principle and has a transparent metering tube. The scale printed onto the metering tube is suited to the medium. Dovetail sections moulded onto the metering tube allow for easy mounting of adjustable visual flow indicators, limit switches and a continuous readout transmitter.

Technical specifications

- **Connection types:** Flange | Spigot | Union end
- **Measuring range - Liquids:** 0.1 to 1600 l/h
- **Measuring range - Gases:** 0.02 to 37.5 Nm³/h
- **Error of measurement:** ± 1% of final value and ± 3% of measured value
- **Media temperature :** -20 to 120 °C
- **Operating pressure :** 0 to 15 bar
- **Nominal sizes:** DN 10 to 25
- **Metering tube materials:** PA | PSU | PVC-U, transparent
- **Float materials:** 1.4571 (316 Ti) | PP | PVC-U | PVDF
- **Conformities:** ATEX

Technical data depends on the respective configuration



further information
webcode: GW-850



Product line GEMÜ 800

Product line



	GEMÜ 801	GEMÜ 805	GEMÜ 806	GEMÜ 807	GEMÜ 811
Working medium					
Gases	●	●	-	●	●
Liquids	●	●	●	●	●
Nominal sizes	DN 20 to 65	DN 20 to 65	DN 65	DN 20 to 65	DN 20 to 65
Metering tube materials					
PA, transparent	●	●	●	●	●
PSU	●	●	●	●	●
PVC-U, transparent	●	●	●	●	●
Magnet					
No	●	●	●	●	-
Yes	-	-	-	-	●
Float materials					
1.4571 (316 Ti)	-	-	●	●	-
PP	-	●	-	-	-
PVC-U	●	-	-	-	●
Conformities					
ATEX	●	●	●	●	●

Product line GEMÜ 800

Product line



GEMÜ 815

GEMÜ 816

GEMÜ 817

GEMÜ 820

GEMÜ 822

	GEMÜ 815	GEMÜ 816	GEMÜ 817	GEMÜ 820	GEMÜ 822
Working medium					
Gases	●	-	●	●	●
Liquids	●	●	●	●	●
Nominal sizes	DN 20 to 65	DN 20 to 65	DN 20 to 65	DN 20 to 50	DN 50
Metering tube materials					
PA, transparent	●	●	●	●	●
PSU	●	●	●	●	●
PVC-U, transparent	●	●	●	●	●
Magnet					
No	-	-	-	●	●
Yes	●	●	●	-	-
Float materials					
1.4571 (316 Ti)	-	●	●	-	-
PP	●	-	-	-	-
PVDF	-	-	-	●	●
Conformities					
ATEX	●	●	●	●	●

Product line GEMÜ 800

Product line



	GEMÜ 825	GEMÜ 830	GEMÜ 831	GEMÜ 832	GEMÜ 835
Working medium					
Gases	●	●	●	●	●
Liquids	-	●	●	●	●
Nominal sizes	DN 20 to 65	DN 20 to 50	DN 20 to 65	DN 20 to 65	DN 20 to 65
Metering tube materials					
PA, transparent	●	●	●	●	●
PSU	●	●	●	●	●
PVC-U, transparent	●	●	●	●	●
Magnet					
No	●	-	-	-	-
Yes	-	●	●	●	●
Float materials					
PP	●	-	-	-	●
PVC-U	-	-	●	-	-
PVDF	-	●	-	●	-
Conformities					
ATEX	●	●	●	●	●

Product line GEMÜ 850

Product line



GEMÜ 851

GEMÜ 855

GEMÜ 857

GEMÜ 861

GEMÜ 865

	GEMÜ 851	GEMÜ 855	GEMÜ 857	GEMÜ 861	GEMÜ 865
Working medium					
Gases	●	●	●	●	●
Liquids	●	●	●	●	●
Nominal sizes	DN 15 to 25	DN 10 to 25	DN 10 to 25	DN 10 to 25	DN 10 to 25
Metering tube materials					
PA, transparent	●	●	●	●	●
PSU	●	●	●	●	●
PVC-U, transparent	●	●	●	●	●
PVDF	●	●	●	-	●
Magnet					
No	●	●	●	-	-
Yes	-	-	-	●	●
Float materials					
1.4571 (316 Ti)	-	-	●	-	-
PP	-	●	-	-	●
PVC-U	●	-	-	●	-
Conformities					
ATEX	●	●	●	●	●

Product line GEMÜ 850

Product line



	GEMÜ 867	GEMÜ 870	GEMÜ 875	GEMÜ 880	GEMÜ 885
Working medium					
Gases	●	●	●	●	●
Liquids	●	●	-	●	●
Nominal sizes	DN 10 to 25	DN 10 to 25	DN 10 to 25	DN 10 to 25	DN 20 to 25
Metering tube materials					
PA, transparent	●	●	●	●	●
PSU	●	●	●	●	●
PVC-U, transparent	●	●	●	●	●
Magnet					
No	-	●	●	-	-
Yes	●	-	-	●	●
Float materials					
1.4571 (316 Ti)	●	-	-	-	-
PP	-	-	●	-	●
PVDF	-	●	-	●	-
Conformities					
ATEX	●	●	●	●	●

Product line GEMÜ 840**Product line****GEMÜ 840****GEMÜ 841****GEMÜ 845****GEMÜ 846**

	GEMÜ 840	GEMÜ 841	GEMÜ 845	GEMÜ 846
Working medium				
Water	●	●	●	●
Nominal size	DN 65	DN 65	DN 65	DN 65
Metering tube materials Main flow unit				
PSU	●	●	●	●
Magnet				
No	●	-	●	-
Yes	-	●	-	●
Float materials				
PP	●	-	●	●
PVC-U	●	●	-	-
Conformities				

Product description

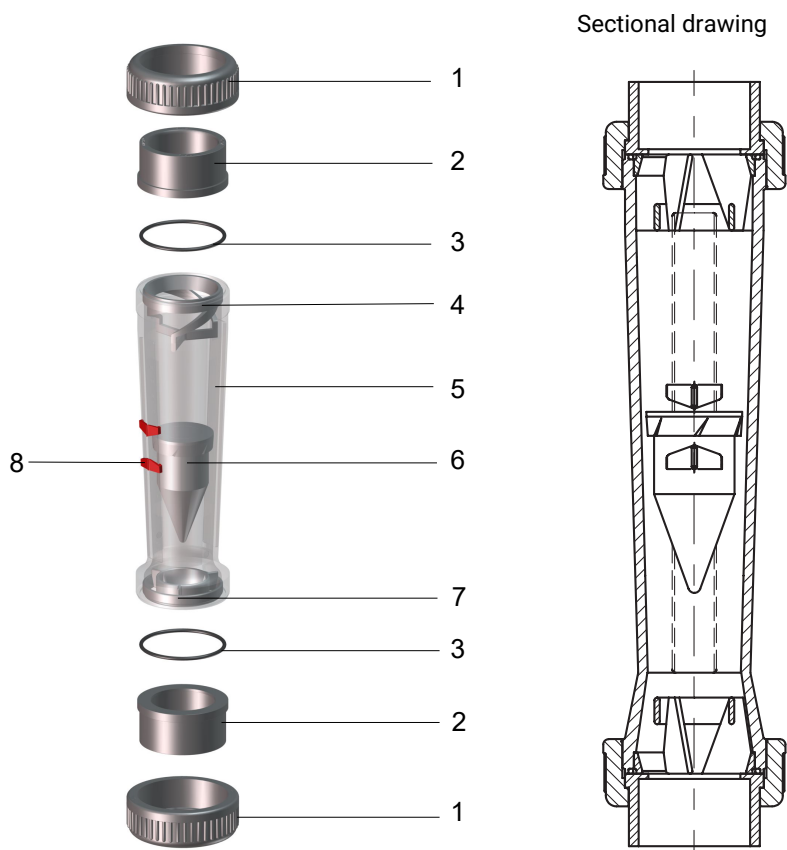

Item	Name	Materials
1	Union nut	PP, PVDF, stainless steel
2	Union (insert)	PVC-C, PP, PVDF, 1.4408, 1.4435, 1.4404, malleable iron
3	O-ring	FPM, EPDM, FEP encapsulated
4	Upper float stop	PP, PVDF
5	Metering tube	PA transparent / Polysulphone (working medium air, water and sodium hydroxide) Polysulphone (working medium hydrochloric acid) PVC-U (working medium air) PVDF on request
6	Float	PVDF, PP, PVC, stainless steel
7	Lower float stop	PP, PVDF
8	Flow indicator	

GEMÜ CONEXO

The interaction of valve components that are equipped with RFID chips and an associated IT infrastructure actively increase process reliability.



Thanks to serialization, every valve and every relevant valve component such as the body, actuator or diaphragm, and even automation components, can be clearly traced and read using the CONEXO pen RFID reader. The CONEXO app, which can be installed on mobile devices, not only facilitates and improves the "installation qualification" process, but also makes the maintenance process much more transparent and easier to document. The app actively guides the maintenance technician through the maintenance schedule and directly provides him with all the information assigned to the valve, such as test reports, testing documentation and maintenance histories. The CONEXO portal acts as a central element, helping to collect, manage and process all data.

For further information on GEMÜ CONEXO please visit:

www.gemu-group.com/conexo

Ordering

GEMÜ Conexo must be ordered separately with the ordering option "CONEXO".

In the corresponding design with CONEXO, this product has an RFID chip (1) for electronic recognition. The position of the RFID chip can be seen below.

Installing the RFID chip

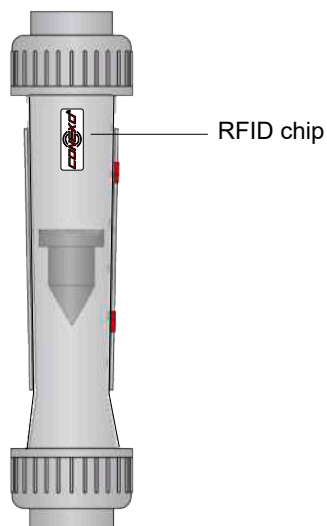

Availability

DN	Union material (code) ¹⁾																						
	1					5					6	7		1, 6, 7, 1V, 2V	20		41, 1V, 2V						
	Connection type (code) ²⁾																						
	4	7	7R	33	39	4	7	39	78	7R	8	39	7R	7	78	0	16	17	18	37	59	60	
10	X	X	X	X	-	-	X	-	-	X	-	-	X	X	-	-	X	X	X	-	X	X	
15	X	X	X	X	X	X	X	X	X	X	X	X	X	X	X	X	X	X	X	-	X	X	
20	X	X	X	X	X	X	X	X	X	X	X	X	X	X	X	X	X	X	X	-	X	X	
25	X	X	X	X	X	X	X	X	X	X	X	X	X	X	X	X	X	X	X	X	X	X	

1) Union material

Code 1: Insert PVC-U, union nut PP grey

Code 1V: Insert 1.4435 (butt weld spigot), insert 1.4404 (Rp threaded socket), PP beige union nut

Code 20: Insert PVDF, union nut PVDF

Code 2V: Insert 1.4435 (butt weld spigot), insert 1.4404 (Rp threaded socket), PVDF union nut

Code 41: Insert 1.4435 (butt weld spigot), union nut stainless steel

Code 5: Insert PP, union nut PP beige

Code 6: Malleable iron

Code 7: Insert 1.4404 (RP threaded socket), union nut stainless steel

2) Connection type

Code 0: Spigot DIN

Code 16: Spigot EN 10357 series B, formerly DIN 11850 series 1

Code 17: Spigot EN 10357 series A (formerly DIN 11850 series 2)

Code 18: Spigot DIN 11850 series 3

Code 37: Spigot SMS 3008

Code 59: Spigot ASME BPE

Code 60: Spigot ISO 1127/EN 10357 series C

Code 33: Union end with inch insert - BS (socket)

Code 7: Union end with DIN insert (socket)

Code 78: Union end with DIN insert (for IR butt welding)

Code 7R: Union end with Rp threaded socket insert

Code 4: Plastic loose backing flange, flange EN 1092, PN 10, form B

Code 8: Flange EN 1092, PN 16, form B

Code 39: Flange ANSI Class 125/150 RF

Selection of scales

All scales in this datasheet are based on a medium temperature of 20 °C.

Scales in % (10 - 100)

Accuracy class: 4 acc. to VDE/VDI 3513, sheet 2, i.e. $\pm 1\%$ of end value and $\pm 3\%$ of measured value.

The scale divisions correspond to the actual flows.

When ordering, the flow ranges should be stated as follows:

Liquid media: l/h

Gaseous media: Nm³/h

Flowmeters for liquid media, types 851, 855, 861, 865

Order code - Types 851¹⁾, 855¹⁾, 861¹⁾, 865¹⁾

DN	Metering tube size code	Water	Hydrochloric acid	Sodium hydroxide		
		H ₂ O	HCl 30-33 %	NaOH 30 %	NaOH 45 %	NaOH 50 %
		Metering tube material				
		PVC-U (code 3) PA (code 21), PSU (code 22)	PVC-U (code 3) PSU (code 22)	PVC-U (code 3) PA (code 21), PSU (code 22)		
10	11	2 - 25	1 - 20	0.25 - 3.75	0.05 - 0.85	0.025 - 0.60
	12	2 - 40	2 - 32	0.50 - 8.00	0.10 - 2.00	0.05 - 1.45
	13	5 - 60	2 - 54	1.00 - 20.0	0.25 - 4.75	0.25 - 3.25
	14	10 - 100	5 - 90	2.50 - 45.0	0.50 - 12.5	0.50 - 9.00
	15	15 - 160	10 - 150	5.00 - 80.0	1.00 - 30.0	1.00 - 22.0
15	21	5 - 60	2.5 - 50	1.0 - 15.0	0.25 - 3.25	0.10 - 2.40
	22	10 - 100	5.0 - 80	2.0 - 34.0	0.50 - 8.00	0.25 - 5.50
	23	15 - 160	10 - 130	2.5 - 67.5	1.00 - 8.00	0.50 - 13.5
	24	20 - 250	20 - 220	5.0 - 130	2.50 - 45.0	2.00 - 32.0
	25	30 - 320	20 - 260	10.0 - 170	2.50 - 65.0	2.50 - 47.5
20	31	10 - 160	10 - 135	2.5 - 62.5	1.0 - 15.0	0.5 - 11
	32	20 - 250	20 - 210	5.0 - 115.0	2.0 - 32.5	1.0 - 24
	33	40 - 400	25 - 325	10 - 190.0	2.5 - 70.0	2.5 - 50
	34	40 - 640	50 - 550	25 - 375.0	10.0 - 180	5.0 - 130
25	41	20 - 250	20 - 200	5 - 110	2.0 - 29	1.0 - 20
	42	40 - 400	30 - 340	10 - 200	2.5 - 70	2.5 - 50
	43	60 - 640	50 - 550	20 - 380	10 - 150	5 - 120
	44	100 - 1000	100 - 900	25 - 650	25 - 350	10 - 260

Unit in l/h

1) Type

Code 851: Variable area flowmeter, PVC float, (series 850)

Code 855: Variable area flowmeter, PP float, (series 850)

Code 861: Variable area flowmeter, PVC float with magnet, (series 850)

Code 865: Variable area flowmeter, PP float with magnet, (series 850)

Flowmeters for liquid media, types 857, 867Order code - Types 857¹⁾, 867¹⁾

DN	Metering tube size code	Water	Hydrochloric acid	Sodium hydroxide		
		H ₂ O	HCl 30-33 %	NaOH 30 %	NaOH 45 %	NaOH 50 %
		Metering tube material				
		PVC-U (code 3) PA (code 21), PSU (code 22)	PVC-U (code 3) PSU (code 22)	PVC-U (code 3) PA (code 21), PSU (code 22)		
10	11	4 - 40	-	0.5 - 8.5	0.10 - 2.0	0.05 - 1.40
	12	5 - 60	-	1.0 - 19.0	0.25 - 4.5	0.25 - 3.25
	13	10 - 100	-	2.5 - 40.0	0.50 - 11	0.5 - 8.00
	14	15 - 160	-	5.0 - 85.0	1.00 - 28	1.0 - 21.0
	15	20 - 250	-	10.0 - 150	2.50 - 60	2.5 - 47.5
15	21	10 - 100	-	2.5 - 37.5	0.5 - 9.0	0.25 - 6.5
	22	20 - 160	-	5.0 - 75.0	1.0 - 22	1.00 - 15
	23	20 - 250	-	5.0 - 140	2.5 - 50	2.00 - 36
	24	40 - 400	-	10.0 - 250	5.0 - 110	5.00 - 85
	25	50 - 500	-	20.0 - 300	10 - 160	5.00 - 120
20	31	20 - 250	-	5 - 135	2.5 - 42.5	2.0 - 30
	32	40 - 400	-	10 - 230	5.0 - 90.0	2.5 - 65
	33	60 - 600	-	25 - 350	10 - 180	5.0 - 135
	34	100 - 1000	-	25 - 650	25 - 400	20 - 320
25	41	40 - 400	-	10 - 220	5.0 - 75	2.5 - 55
	42	50 - 650	-	20 - 380	10 - 180	5 - 135
	43	100 - 1000	-	25 - 650	25 - 400	20 - 300
	44	150 - 1600	-	50 - 1100	50 - 750	25 - 650

Unit in l/h

1) **Type**

Code 857: Variable area flowmeter, 1.4571 (316Ti) stainless steel float, (series 850)

Code 867: Variable area flowmeter, 1.4571 (316Ti) stainless steel float with magnet, (series 850)

Flowmeters for liquid media, types 870, 880

Order code - Types 870¹⁾, 880¹⁾

DN	Metering tube size code	Water	Hydrochloric acid	Sodium hydroxide		
		H ₂ O	HCl 30-33 %	NaOH 30 %	NaOH 45 %	NaOH 50 %
		Metering tube material				
		PVC-U (code 3) PA (code 21), PSU (code 22)	PVC-U (code 3) PSU (code 22)	PVC-U (code 3) PA (code 21), PSU (code 22)		
10	11	2 - 25	1 - 20	-	-	-
	12	2 - 40	2 - 32	-	-	-
	13	5 - 60	2 - 54	-	-	-
	14	10 - 100	5 - 90	-	-	-
	15	15 - 160	10 - 150	-	-	-
15	21	5 - 60	2.5 - 50	-	-	-
	22	10 - 100	5.0 - 80	-	-	-
	23	15 - 160	10 - 130	-	-	-
	24	20 - 250	20 - 220	-	-	-
	25	30 - 320	20 - 260	-	-	-
20	31	10 - 160	10 - 135	-	-	-
	32	20 - 250	20 - 210	-	-	-
	33	40 - 400	25 - 325	-	-	-
	34	40 - 640	50 - 550	-	-	-
25	41	20 - 250	20 - 200	-	-	-
	42	40 - 400	30 - 340	-	-	-
	43	60 - 640	50 - 550	-	-	-
	44	100 - 1000	100 - 900	-	-	-

Unit in l/h

1) Type

Code 870: Variable area flowmeter, PVDF float, (series 850)

Code 880: Variable area flowmeter, PVDF float with magnet, (series 850)

Flowmeter for gaseous media, type 875

Caution! With gaseous media the scaling alters according to operating pressure. Please state when ordering.

Standard conditions to DIN 1343

Order code - Type 875¹⁾

DN	Metering tube size	Medium air
		Metering tube material
		PA (code 21), PSU (code 22)
10	11	0.02 - 0.36
	12	0.05 - 0.55
	13	0.10 - 0.90
	14	0.15 - 1.50
	15	0.20 - 2.40
15	21	0.10 - 0.90
	22	0.15 - 1.50

Selection of scales

DN	Metering tube size	Medium air
		Metering tube material
		PA (code 21), PSU (code 22)
	23	0.20 - 2.40
	24	0.40 - 3.80
	25	0.40 - 4.80
20	31	0.20 - 2.50
	32	0.25 - 3.75
	33	0.50 - 5.50
	34	1.00 - 10.0
25	41	0.4 - 4.00
	42	0.5 - 6.00
	43	1.0 - 10.0
	44	1.0 - 16.0

Unit in Nm³/h

1) Type

Code 875: Variable area flowmeter, PP float, (series 850)

Flowmeter for gaseous media, type 885

Caution! With gaseous media the scaling alters according to operating pressure. Please state when ordering.

Standard conditions to DIN 1343

Order code - Type 885¹⁾

DN	Metering tube size	Medium air
		Metering tube material
		PA (code 21), PSU (code 22)
20	31	0.75 - 6.5
	32	1.0 - 10.0
	33	1.5 - 14.5
	34	2.0 - 24.0
25	41	1.0 - 10.0
	42	1.0 - 15.0
	43	3.0 - 24.0
	44	5.0 - 37.5

Unit in Nm³/h

1) Type

Code 885: Variable area flowmeter, PP float with magnet, (series 850)

Order data

The order data provide an overview of standard configurations.

Please check the availability before ordering. Other configurations available on request.

The following data are necessary:

1. Type of medium
2. Concentration of medium (%)
3. Required flow range (l/h, m³/h, kg/h)
4. Operating pressure, relative or absolute (bar)
5. Temperature of medium (°C)
6. Viscosity of medium
7. Medium density
8. Float with or without magnet

Order codes

1 Type	Code
Variable area flowmeter, PVC float, (series 850)	851
Variable area flowmeter, PP float, (series 850)	855
Variable area flowmeter, 1.4571 (316Ti) stainless steel float, (series 850)	857
Variable area flowmeter, PVC float with magnet, (series 850)	861
Variable area flowmeter, PP float with magnet, (series 850)	865
Variable area flowmeter, 1.4571 (316Ti) stainless steel float with magnet, (series 850)	867
Variable area flowmeter, PVDF float, (series 850)	870
Variable area flowmeter, PP float, (series 850)	875
Variable area flowmeter, PVDF float with magnet, (series 850)	880
Variable area flowmeter, PP float with magnet, (series 850)	885

2 RoHS conformance	Code
Conformance to RoHS	R

3 DN	Code
DN 10	10
DN 15	15
DN 20	20
DN 25	25

4 Body configuration	Code
Straight through pipe	D

5 Connection type	Code
Union end with DIN insert (socket)	7
Union end with inch insert - BS (socket)	33
Union end with DIN insert (for IR butt welding)	78
Union end with Rp threaded socket insert	7R
Spigot DIN	0
Spigot EN 10357 series B, formerly DIN 11850 series 1	16
Spigot EN 10357 series A (formerly DIN 11850 series 2)	17
Spigot DIN 11850 series 3	18
Spigot SMS 3008	37
Spigot ASME BPE	59
Spigot ISO 1127/EN 10357 series C	60
Plastic loose backing flange, flange EN 1092, PN 10, form B	4
Flange EN 1092, PN 16, form B	8
Flange ANSI Class 125/150 RF	39

6 Metering tube material	Code
PVC-U, transparent	3
PVDF	20
PA, transparent	21
PSU	22

7 O-ring material	Code
FPM	4
EPDM	14
FEP encapsulated	55

8 Union material	Code
Insert PVC-U, union nut PP grey	1
Insert PP, union nut PP beige	5
Malleable iron	6
Insert 1.4404 (RP threaded socket), union nut stainless steel	7
Insert PVDF, union nut PVDF	20
Insert 1.4435 (butt weld spigot), union nut stainless steel	41

Order data

8 Union material	Code
Insert 1.4435 (butt weld spigot), insert 1.4404 (Rp threaded socket), PP beige union nut	1V
Insert 1.4435 (butt weld spigot), insert 1.4404 (Rp threaded socket), PVDF union nut	2V

9 Metering tube size	Code
See table	

10 Measuring range	Code
See table	

11 CONEXO	Code
Without	
Integrated RFID chip for electronic identification and traceability	C

Order example

Ordering option	Code	Description
1 Type	855	Variable area flowmeter, PP float, (series 850)
2 RoHS conformance	R	Conformance to RoHS
3 DN	10	DN 10
4 Body configuration	D	Straight through pipe
5 Connection type	7	Union end with DIN insert (socket)
6 Metering tube material	21	PA, transparent
7 O-ring material	14	EPDM
8 Union material	1	Insert PVC-U, union nut PP grey
9 Metering tube size		See table
10 Measuring range		See table
11 CONEXO		Without

Technical data

Medium

Working medium: Corrosive and inert gaseous and liquid media which have no negative impact on the physical and chemical properties of the metering tube, float, seal and union materials as well as other media wetted parts.

Temperature

Storage temperature: 0 – 40 °C

Media temperature: -20 – 120 °C

Pressure

Operating pressure: Metering tubes with plastic unions: Max. 10 bar
Metering tubes with metal unions: Max. 15 bar

Pressure loss:

DN	Type Code				
	851	855, 861, 865, 870, 880	857, 867	875	885
10	-	5	10	1	-
15	6	6	12	1.5	-
20	8	8	17	2	11
25	10	10	19	2.5	13

Pressures in mbar

Medium: Water, 20 °C

Pressure/temperature correlation

Metering tube material code ¹⁾	Union material code ²⁾	Temperature																
		-20	-10	±0	5	10	20	25	30	40	50	60	70	80	90	100	110	120
		Permissible operating pressure																
3	1	-	-	-	10.0	10.0	10.0	10.0	8.0	6.0	3.5	-	-	-	-	-	-	-
	6	-	-	-	10.0	10.0	10.0	10.0	8.0	6.0	3.5	-	-	-	-	-	-	-
	7	-	-	-	10.0	10.0	10.0	10.0	8.0	6.0	3.5	-	-	-	-	-	-	-
	1V	-	-	-	10.0	10.0	10.0	10.0	8.0	6.0	3.5	-	-	-	-	-	-	-
20	20	10.0	10.0	10.0	10.0	10.0	10.0	10.0	9.0	8.0	7.1	6.3	5.4	4.7	3.6	2.5	1.7	1.2
	7/41	10.0	10.0	10.0	10.0	10.0	10.0	10.0	9.0	8.0	7.1	6.3	5.4	4.7	3.6	2.5	1.7	1.2
	2V	10.0	10.0	10.0	10.0	10.0	10.0	10.0	9.0	8.0	7.1	6.3	5.4	4.7	3.6	2.5	1.7	1.2
21	1	-	-	-	10.0	10.0	10.0	10.0	8.0	6.0	3.5	1.5	-	-	-	-	-	-
	5	-	-	-	10.0	10.0	10.0	10.0	8.5	7.0	5.5	4.0	-	-	-	-	-	-
	20	10.0	10.0	10.0	10.0	10.0	10.0	10.0	9.0	8.0	7.1	6.3	-	-	-	-	-	-
	6	15.0	15.0	15.0	15.0	15.0	15.0	15.0	13.5	12.0	10.7	9.5	-	-	-	-	-	-
	7/41	15.0	15.0	15.0	15.0	15.0	15.0	15.0	13.5	12.0	10.7	9.5	-	-	-	-	-	-
	1V	-	-	-	10.0	10.0	10.0	10.0	8.5	7.0	5.5	4.0	-	-	-	-	-	-

Technical data

Metering tube material code ¹⁾	Union material code ²⁾	Temperature																
		-20	-10	±0	5	10	20	25	30	40	50	60	70	80	90	100	110	120
		Permissible operating pressure																
22	1V	-	-	-	10.0	10.0	10.0	10.0	8.5	7.0	5.5	4.0	2.7	1.5	0.8	-	-	-
	1	-	-	-	10.0	10.0	10.0	10.0	8.0	6.0	3.5	1.5	-	-	-	-	-	-
	5	-	-	-	10.0	10.0	10.0	10.0	8.5	7.0	5.5	4.0	2.7	1.5	0.8	-	-	-
	20	-	-	-	10.0	10.0	10.0	10.0	9.0	8.0	7.1	6.3	5.4	4.7	3.6	2.5	-	-
	6	-	-	-	15.0	15.0	15.0	15.0	14.0	13.0	12.0	11.0	9.7	8.5	7.7	6.0	-	-
	7/41	-	-	-	15.0	15.0	15.0	15.0	14.0	13.0	12.0	11.0	9.7	8.5	7.7	6.0	-	-

Temperatures in °C

Permissible operating pressure in bar

For flowmeters that have a permanent magnet in the float, the max. temperature is 80 °C.

1) Metering tube material

Code 3: PVC-U, transparent

Code 20: PVDF

Code 21: PA, transparent

Code 22: PSU

2) Union material

Code 1: Insert PVC-U, union nut PP grey

Code 1V: Insert 1.4435 (butt weld spigot), insert 1.4404 (Rp threaded socket), PP beige union nut

Code 20: Insert PVDF, union nut PVDF

Code 2V: Insert 1.4435 (butt weld spigot), insert 1.4404 (Rp threaded socket), PVDF union nut

Code 41: Insert 1.4435 (butt weld spigot), union nut stainless steel

Code 5: Insert PP, union nut PP beige

Code 6: Malleable iron

Code 7: Insert 1.4404 (RP threaded socket), union nut stainless steel

Mechanical data

Weight:

DN	Metering tube size code	For liquid media				For gaseous media	
		Type					
		851, 855, 861, 865, 870, 880		857, 867		875, 885	
		Union material					
		PVC-U	Malleable iron	PVC-U	Malleable iron	PVC-U	Malleable iron
10	11, 12, 13, 14, 15	0.07	0.18	0.08	0.19	0.07	0.18
15	21, 22, 23, 24, 25	0.12	0.3	0.13	0.31	0.11	0.29
20	31, 32, 33, 34,	0.21	0.48	0.24	0.51	0.19	0.46
40	41, 42, 43, 44	0.29	0.61	0.34	0.66	0.25	0.57

Weights in kg

Dimensions

Plastic union

Union end with DIN insert, inch-BS (socket)

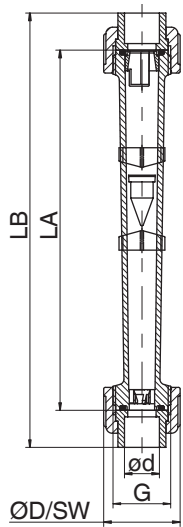

DN	Connection type code ¹⁾										
	7, 33				7	33	7			33	7
	Union material code ²⁾										
	1, 5, 20				1		5	20	1	1, 5, 20	
	G	LA	O-ring	øD / SW	LB				ød		
10	G 3/4	165.0	15.5 x 2.6	35.0	199.0	209.0	199.0	199.0	17.3	16.0	
15	G 1	170.0	20.2 x 3.5	43.0	208.0	208.0	205.0	108.0	21.4	20.0	
20	G 1¼	185.0	28.0 x 3.5	53.0	229.0	229.0	223.0	227.0	26.7	25.0	
25	G 1½	200.0	33.0 x 3.5	60.0	250.0	250.0	242.0	246.0	33.6	32.0	

Dimensions in mm

Dimension L of metering tube material PVDF (code 20) reduced by 3 mm.

1) Connection type

Code 7: Union end with DIN insert (socket)

Code 33: Union end with inch insert - BS (socket)

2) Union material

Code 1: Insert PVC-U, union nut PP grey

Code 5: Insert PP, union nut PP beige

Code 20: Insert PVDF, union nut PVDF

Union end with DIN insert (butt welding, IR)

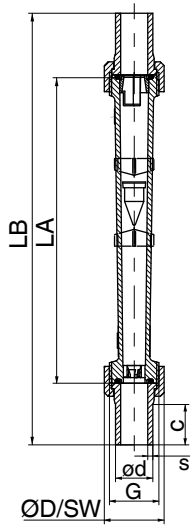

DN	Connection type code 78 ¹⁾								
	Union material code ²⁾								
	5, 20							5	20
	G	LA	O-ring	øD / SW	c	LB	ød	s	
10	G 3/4	165.0	15.5 x 2.6	35.0	-	-	-	-	-
15	G 1	170.0	20.2 x 3.5	43.0	37.0	276.0	20.0	1.9	1.9
20	G 1¼	185.0	28.0 x 3.5	53.0	39.0	297.0	25.0	2.3	1.9
25	G 1½	200.0	33.0 x 3.5	60.0	40.0	318.0	32.0	2.9	2.4

Dimensions in mm

Dimension L of metering tube material PVDF (code 20) reduced by 3 mm.

1) **Connection type**

Code 78: Union end with DIN insert (for IR butt welding)

2) **Union material**

Code 5: Insert PP, union nut PP beige

Code 20: Insert PVDF, union nut PVDF

Metal and plastic union

Union end with Rp threaded socket insert

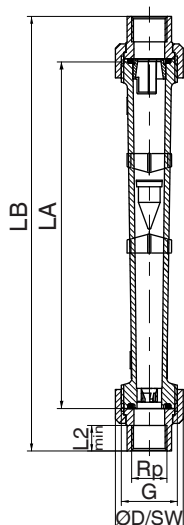

DN	Connection type code 7R ¹⁾										
	Union material code ²⁾										
	1, 6, 7		1, 6, 7, 1V, 2V		6, 7		1	6	7	1, 1V, 2V	
	G	LA	O-ring	Rp	L2 min	øD / SW		LB			ød
10	G 3/4	165.0	15.5 x 2.6	RP 3/8	11.4	32.0	32.0	199.0	209.0	203.0	35.0
15	G 1	170.0	20.2 x 3.5	RP 1/2	15.0	41.0	41.0	208.0	214.0	212.0	43.0
20	G 1¼	185.0	28.0 x 3.5	RP 3/4	16.3	50.0	50.0	229.0	229.0	239.0	53.0
25	G 1½	200.0	33.0 x 3.5	RP 1	19.1	55.0	55.0	250.0	252.0	256.0	60.0

Dimensions in mm

Dimension L of metering tube material PVDF (code 20) reduced by 3 mm.

1) Connection type

Code 7R: Union end with Rp threaded socket insert

2) Union material

Code 1: Insert PVC-U, union nut PP grey

Code 1V: Insert 1.4435 (butt weld spigot), insert 1.4404 (Rp threaded socket), PP beige union nut

Code 2V: Insert 1.4435 (butt weld spigot), insert 1.4404 (Rp threaded socket), PVDF union nut

Code 6: Malleable iron

Code 7: Insert 1.4404 (Rp threaded socket), union nut stainless steel

Metal union for spigot DIN

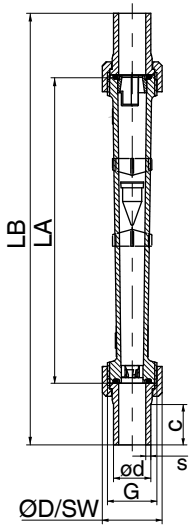

DN	Connection type code ¹⁾														
	0, 16, 17, 18				18	17	0	16	16	0	17	18			
	Union material Code ²⁾														
	G	LA	O-ring	41	1V, 2V	41, 1V, 2V									
			SW	ØD	c	LB	ød				s				
10	G 3/4	165.0	15.5 x 2.6	32.0	35.0	34.0	240.0	14.0	13.0	-	12.0	1.0	-	1.5	2.0
15	G 1	170.0	20.2 x 3.5	41.0	43.0	34.0	246.0	20.0	19.0	18.0	18.0	1.0	1.5	1.5	2.0
20	G 1¼	185.0	28.0 x 3.5	50.0	53.0	34.0	261.0	24.0	23.0	22.0	22.0	1.0	1.5	1.5	2.0
25	G 1½	200.0	33.0 x 3.5	55.0	60.0	34.0	279.0	30.0	29.0	28.0	28.0	1.0	1.5	1.5	2.0

Dimensions in mm

Dimension L of metering tube material PVDF (code 20) reduced by 3 mm.

1) **Connection type**

Code 0: Spigot DIN

Code 16: Spigot EN 10357 series B, formerly DIN 11850 series 1

Code 17: Spigot EN 10357 series A (formerly DIN 11850 series 2)

Code 18: Spigot DIN 11850 series 3

2) **Union material**

Code 1V: Insert 1.4435 (butt weld spigot), insert 1.4404 (Rp threaded socket), PP beige union nut

Code 2V: Insert 1.4435 (butt weld spigot), insert 1.4404 (Rp threaded socket), PVDF union nut

Code 41: Insert 1.4435 (butt weld spigot), union nut stainless steel

Metal union for spigot SMS, ASME, ISO

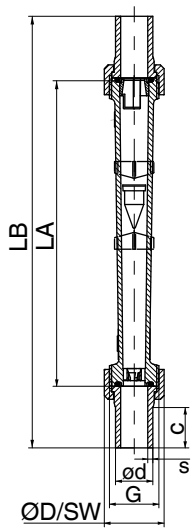

DN	Connection type code ¹⁾												
	37, 59, 60						60	37	59	60	59	37	
	Union material code ²⁾												
	G	LA	O-ring	41	1V, 2V	41, 1V, 2V							
			SW	ØD	c	LB	ød		s				
10	G 3/4	165.0	15.5 x 2.6	32.0	35.0	34.0	240.0	17.2	-	9.5	1.6	0.9	-
15	G 1	170.0	20.2 x 3.5	41.0	43.0	34.0	246.0	21.3	-	12.7	1.6	1.65	-
20	G 1¼	185.0	28.0 x 3.5	50.0	53.0	34.0	261.0	26.9	-	19.1	1.6	1.65	-
25	G 1½	200.0	33.0 x 3.5	55.0	60.0	34.0	279.0	33.7	25.0	25.4	1.6	1.65	1.2

Dimensions in mm

Dimension L of metering tube material PVDF (code 20) reduced by 3 mm.

1) Connection type

Code 0: Spigot DIN

Code 16: Spigot EN 10357 series B, formerly DIN 11850 series 1

Code 17: Spigot EN 10357 series A (formerly DIN 11850 series 2)

Code 18: Spigot DIN 11850 series 3

2) Union material

Code 1V: Insert 1.4435 (butt weld spigot), insert 1.4404 (Rp threaded socket), PP beige union nut

Code 2V: Insert 1.4435 (butt weld spigot), insert 1.4404 (Rp threaded socket), PVDF union nut

Code 41: Insert 1.4435 (butt weld spigot), union nut stainless steel

Flange connection code 4, 8, 39

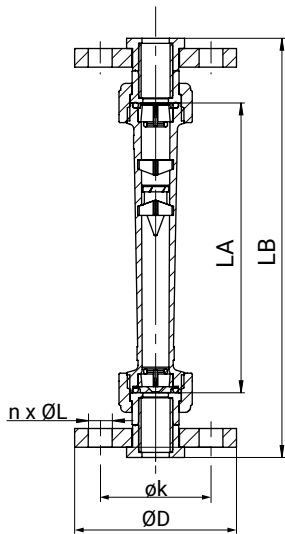

DN	Connection type (code) ¹⁾									
	4, 8, 39		4, 39		8, 39	4, 8, 39	4	8, 39	4, 8	39
	Union material (code) ²⁾									
	1, 5, 7		1	5	7	1, 5, 7	1, 5,	1, 5, 7		
	LA	O-ring	LB			ØD	øk		n x ØL	
10	165.0	15.5 x 2.6	241.0	-	-	90.0	55.0	-	4 x 14.0	-
15	170.0	20.2 x 3.5	246.0	256.0	305.0	95.0	65.0	60.0	4 x 14.0	4 x 16.0
20	185.0	28.0 x 3.5	273.0	279.0	326.0	105.0	75.0	70.0	4 x 14.0	4 x 16.0
25	200.0	33.0 x 3.5	300.0	302.0	344.0	115.0	85.0	79.0	4 x 14.0	4 x 16.0

Dimensions in mm

1) **Connection type**

- Code 4: Plastic loose backing flange, flange EN 1092, PN 10, form B
- Code 8: Flange EN 1092, PN 16, form B
- Code 39: Flange ANSI Class 125/150 RF

2) **Union material**

- Code 1: Insert PVC-U, union nut PP grey
- Code 5: Insert PP, union nut PP beige
- Code 7: Insert 1.4404 (RP threaded socket), union nut stainless steel

Accessories

Information on accessories for 800, 840, 850

To increase the versatility of GEMÜ flowmeters, numerous accessories have been developed which can be retrofitted onto the metering tube without modification.

The float, however, must be one containing a magnet, in order for these accessories to function.



GEMÜ 125x

Limit switches

Limit switches with bistable reed contact (change-over contact or make contact) can be combined with GEMÜ flowmeters with magnetic float. They can be easily mounted and adjusted by clamping them onto the flowmeter. The electrical connection is via a cable gland. An ATEX version is available on request.



GEMÜ 1276

Digital display unit

The GEMÜ 1276 digital display unit is available as types M11 (4-digit) and M21, M31 (5-digit). The device can be programmed at the front using a disconnectable keypad. Programming is made using the easy to understand menu guidance.



GEMÜ 127x

Instrument sensor

Instrument sensors are suitable for continuous flow monitoring of GEMÜ flowmeters with magnetic float. They can be easily mounted and adjusted by clamping them onto the flowmeter. The electrical connection is via a cable gland.



GEMÜ Gebr. Müller Apparatebau GmbH & Co. KG
Fritz-Müller-Straße 6-8, 74653 Ingelfingen-Criesbach, Germany
Phone +49 (0) 7940 1230 · info@gemu.de
www.gemu-group.com