

THE ALPHA MOTOR DRIVEN DOSING PUMPS FROM PROMINENT.
ROBUST PUMPS FOR SIMPLE DOSING TASKS.

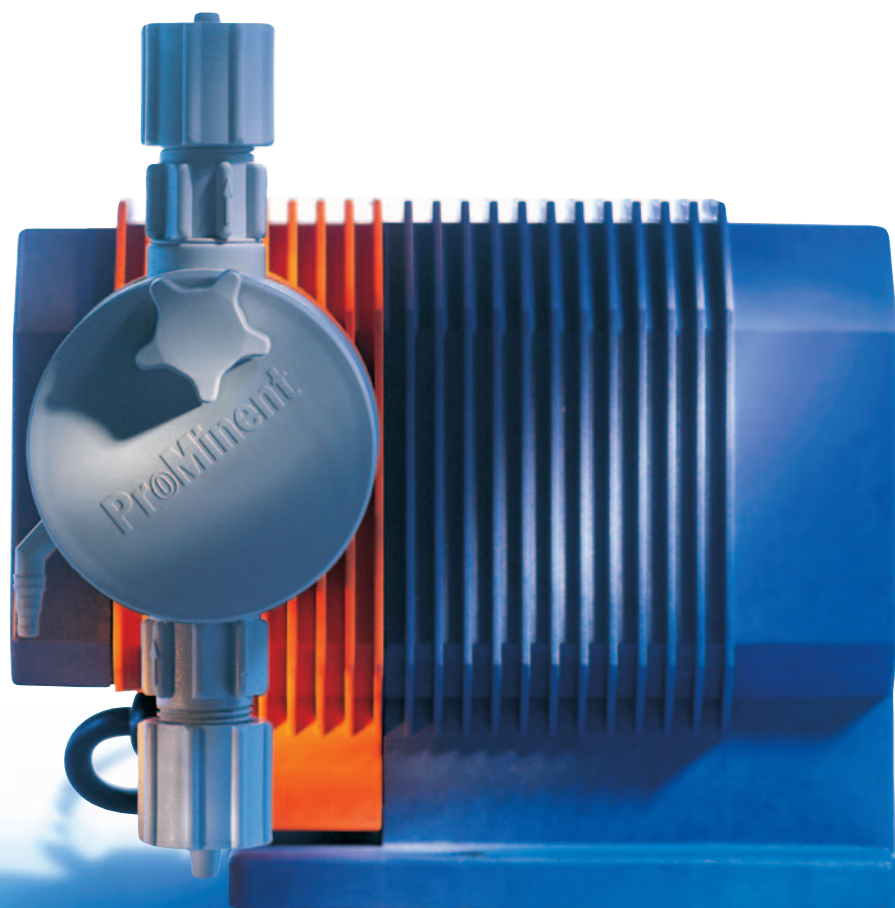

VERSATILE



ProMinent®

ALPHA: DOSING MADE SIMPLE, MAXIMUM OUTPUT, MINIMUM INPUT.



alpha in action: alpha pumps can be used for dosing practically all chemicals in general use

alpha is the first in ProMinent's ABC of dosing pumps. The pumps in the alpha range were developed primarily for simple dosing tasks involving constant dosing quantities. They are

designed for robust, uncomplicated continuous operation and ease of use. The small power package is ideally suited to a wide range of dosing tasks. Four motors with different gear ratios and

different sized liquid ends made from polypropylene or Plexiglas/PVC make the alpha the patent solution for many application areas.



alpha, simply ideal for simple dosing tasks - thanks to its robust uncomplicated design.



Modular construction; universal application: feed rate of 0.5 to 18.5 l/h at 10 to 4 bar.



Simple dosing adjustment via 10 % stroke length variation.



The liquid ends are available in three sizes and two materials. As a result, the alpha is suitable for a whole variety of applications.



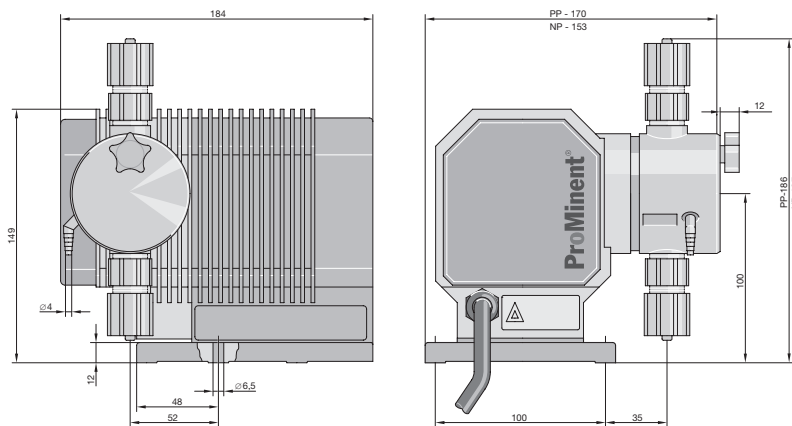

Materials in contact with chemicals

Version	Liquid end	Suction pressure connector	Seals	Valve balls	Patented bleed system
PP1	Polypropylene	Polypropylene	EPDM	Ceramic	Yes
PP2	Polypropylene	Polypropylene	FPM A (Viton® A)	Ceramic	Yes
PP3	Polypropylene	Polypropylene	FPM A (Viton® B)	Ceramic	Yes
NP3	Acrylgias (PMMA)	PVC	FPM B (Viton® B)	Ceramic	Yes
NP6	Acrylgias (PMMA)	PVC	FPM (Viton®)	Ceramic	No

LONG-LIFE

Operation and installation of the liquid end is very simple. The device is switched on and off at the mains. The feed rate is altered by varying the stroke length in 10 % steps when the pump is at rest. The stroke frequency remains constant. The alpha's technical construction guarantees a long and reliable operating life in many application areas. A smooth sinusoidal stroke action for suction and discharge strokes provides the basis for good suction capacity and constant precision dosing along with minimal mechanical stress to the dosing diaphragm. This is the "heart" of the liquid end. The effectiveness of the DEVELOPAN® dosing diaphragm has been proven around the world in more than a million ProMinent® dosing pumps. Installed in the alpha it ensures long lasting problem-free operation.

50 Hz version	Max. pump capacity at maximum back pressure		Max. pump capacity at medium back pressure		Stroke frequency at max. back pressure	Connector-size outer x inner dia.	Suction lift	Shipping-weight
	bar	l/h	bar	l/h				
Pump type alpha					Strokes/min.	mm	water column m	kg
1001	10.0	1.2	5	1.3	30	8 x 5	6	3
1002	10.0	2.4	5	2.6	58	8 x 5	6	3
1003	10.0	3.5	5	3.8	88	8 x 5	6	3
0804	7.5	4.0	4	4.4	30	8 x 5	6	3
0808	7.5	8.0	4	8.5	58	8 x 5	6	3
0612	5.5	12.0	3	12.7	88	8 x 5	6	3
0419	4.0	18.5	2	19.8	128	8 x 5	6	3

DEVELOPAN® dosing diaphragm with PTFE coating is the registered trademark of ProMinent.

Viton® is the registered trademark of DuPont Dow Elastomers.

Delivery range: dosing pump with mains lead (2 m) and plug. Connector set for hose/pipe connection as shown in table.

ALPHA EXTRAS: FULL RANGE OF ACCESSORIES AND WORLDWIDE SERVICE.



ProMinent service ensures the reliable operation of your equipment



The broad palette of accessories and capacities that make up

easy task. Our experience in this area is a valuable extra from ProMinent and is always available to you. Whether for simple dosing tasks or a complex system, we are always glad to advise you on the best solution to

times" a thing of the past. Your operations can continue unimpaired. You see: you can count on ProMinent, our service and the alpha pump range. All round reliable performance; practical and simple to use, the latest dosing tech-

COMPLETE

the alpha range make creating optimal tailor-made solutions for your applications a quick and

your dosing requirements. And so that everything runs smoothly: ProMinent service is always available on every continent - our product range, servicing teams and rapid parts replacement make "down



All in hand: the complete accessories range for individual applications

nology, excellent cost-of-ownership ratio - alpha from ProMinent is the right choice when you're looking for reliable solutions to simple dosing tasks.



Subject to technical alteration.
Printed in Germany / PT ALP 006 08/04 GB

Addresses and supplier information from the manufacturer:

ProMinent Dosiertechnik GmbH
Im Schuhmachergewann 5-11
69123 Heidelberg · Germany
Tel. +49 6221 842-0
Fax +49 6221 842-419
info@prominent.de
www.prominent.com

ProMinent[®]

SERIAL SUCCESS: PROMINENT® MOTOR-DRIVEN DIAPHRAGM METERING PUMPS

ProMinent® alpha

Capacity range:
Up to 10 bar
Up to 21 l/h

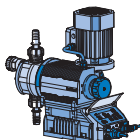
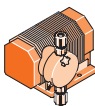

**ProMinent®
Sigma/ 1**
Capacity range:
Up to 12 bar
Up to 120 l/h

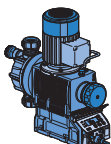

**ProMinent®
Sigma/ 2**
Capacity range:
Up to 12 bar
Up to 350 l/h

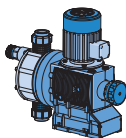

**ProMinent®
Sigma/ 3**
Capacity range:
Up to 12 bar
Up to 1030 l/h

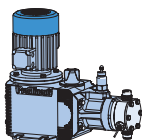

**ProMinent®
Hydro**
Capacity range:
Up to 64 bar
Up to 150 l/h

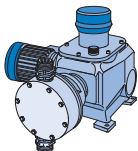

**ProMinent®
Makro TZ HM/HMH**
Capacity range:
Up to 16 bar
Up to 2500 l/h

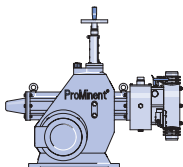

**ProMinent®
Makro/ 5 HM/HMH**
Capacity range:
Up to 25 bar
Up to 6000 l/h

PROMINENT® MOTOR-DRIVEN PISTON METERING PUMPS

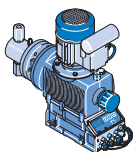

**ProMinent®
Sigma/ 2 HK**
Capacity range:
Up to 320 bar
Up to 76 l/h

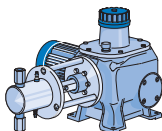

**ProMinent®
Makro TZ HK**
Capacity range:
Up to 320 bar
Up to 1141 l/h

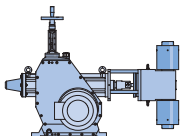

**ProMinent®
Makro/ 5 HK**
Capacity range:
Up to 320 bar
Up to 6000 l/h



the DEVELOPAN® dosing diaphragm has been proven around the world in more than a million ProMinent® dosing pumps. Installed in the alpha it ensures long lasting problem-free operation.

Pump type alpha

Motor data

Type

Split pole motor with integrated thermal overload protection

Power supply

220-240 V, 50/60 Hz (variant A)

Capacity

50 W (at 230 V/50 Hz)

Power consumption

0.4 A (at 230 V/50 Hz)